

# germanShock®

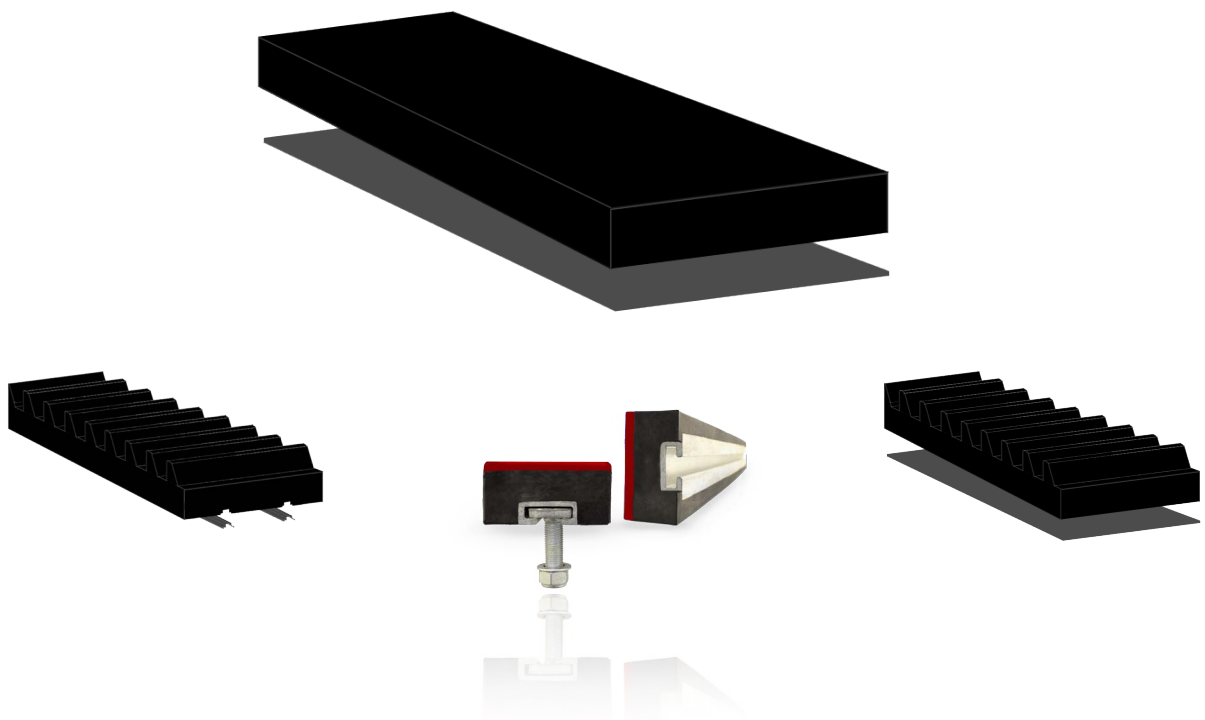

quality ... beyond expectations



## We've got something against wear

germanBelt – quality without compromise

We want nothing to wear out. Our offers for targeted wear protection help you to preserve your systems, reduce repair costs for your machinery or costs for spare parts: Wear-protected plants are more profitable.



Our germanShock protection products are comfortable and easy to handle. They can easily be integrated into systems particularly prone to stress by falling bulk materials or where transported goods cause frictional stress. Naturally, we also offer individual solutions for your specific requirements. This we guarantee with our seal of quality, "certified by germanBelt".

Quality is our promise. There can be no compromise. We provide you with high quality advice on applications, professional planning by our engineers and, of course, full service at any time. In all phases of process, we pay highest attention to unconditional efficiency and the best benefits for our customers.

We know how to fight wear. See for yourself!

### Uwe Hickmann

Managing Partner, germanBelt Group



Wear-protected plants are more profitable. We know how to fight wear.

## germanShock® Product Range

### Contents

PAGE	SUBJECT
02	We've got something against wear
03	Contents
04	Plant protection of the highest standard
05	Shock absorbers
06	Wear protection components
09	General view

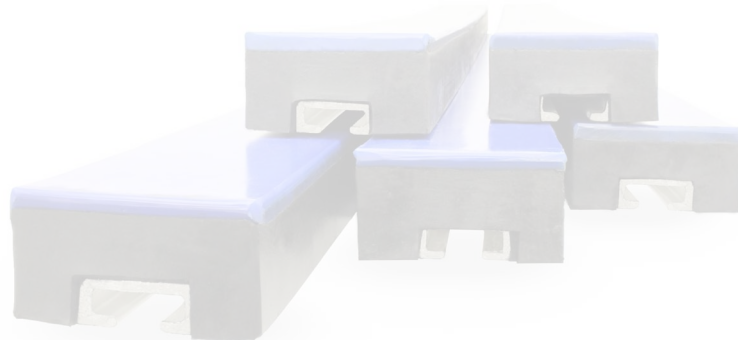

# germanShock®

## Plant protection of the highest standard

germanShock stands for a variety of different products with a wide range of applications, especially for applications with loads of wear by sliding and impact. With its particularly high quality products, our germanShock product range comprises the most recent developments in the field of plant protection. They display high wear resistance, offer an optimum in capacity and are easy to handle. High quality standards make germanShock products into an efficient wear protector.

- **HIGH WEAR RESISTANCE**
- **OPTIMAL CAPACITY**
- **FAST AND EASY INSTALLATION**
- **NOISE REDUCTION**
- **COST REDUCTION**

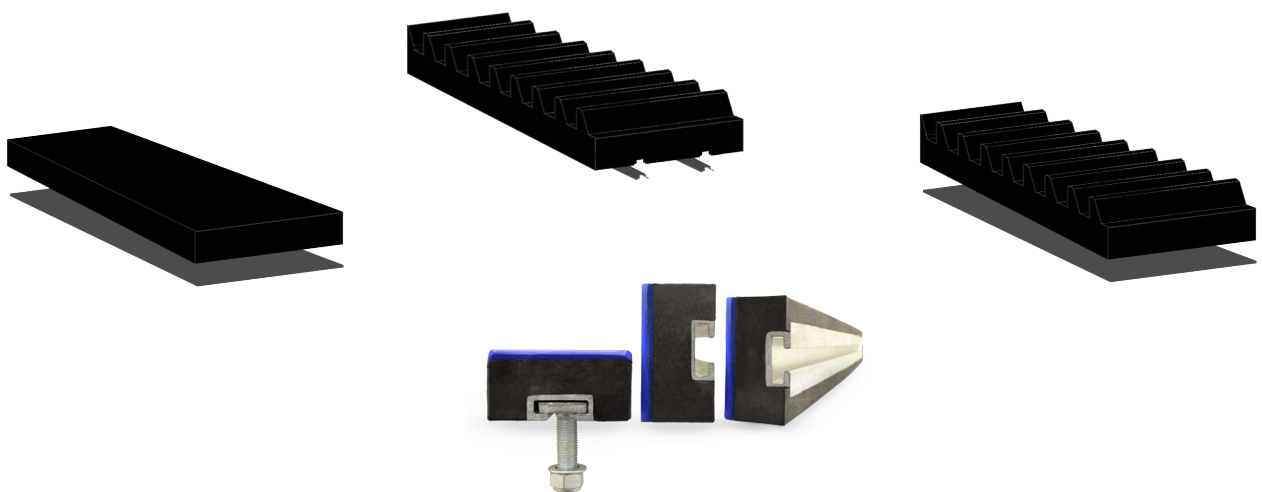

## Shock absorbers

germanShock shock impact bars absorb the high kinetic energy of falling objects and minimise impact stress on belts, machinery and plants. They provide optimal protection against belt damage at the loading point.

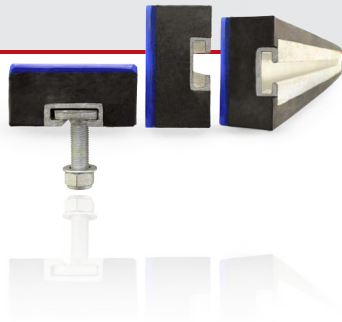

### germanShock® IP 60

**Available dimensions:**

Height:	50/75/100 mm
Width:	100 mm
Length:	1,220/1,500 mm

**Specifications:**

Colour (UHMWPE):	blue
Hardness:	60° [Shore A]
Mounting:	Vulcanised aluminium fastening profile

**Note:** germanShock IP elements come with 10 mm top cover of UHMWPE.  
Please order germanShock IP B fasteners separately. Special materials on request.



### germanShock® IP 45

**Available dimensions:**

Height:	50/75/100 mm
Width:	100 mm
Length:	1,220/1,500 mm

**Specifications:**

Colour (UHMWPE):	red
Hardness:	45° [Shore A]
Mounting:	Vulcanised aluminium fastening profile

**Note:** germanShock IP elements come with 10 mm top cover of UHMWPE.  
Please order germanShock IP B fasteners separately. Special materials on request.

## Wear protection components

By selecting a suitable germanShock component wear and noise problems can be reduced. germanShock wear protection components absorb the impact energy in slides, chutes, bunkers, hoppers, lorry tipping troughs and provide economic solutions for the entire process of material handling. Our germanShock profiled elements are used to optimize the impact angle of the bulk material. Noise and cost reduction: Your benefit.

- **PLAIN AND PROFILED**
- **FLEXIBLE MOUNTING**
- **INCREASED SYSTEMS AVAILABILITY**
- **LOWER MAINTENANCE COSTS**

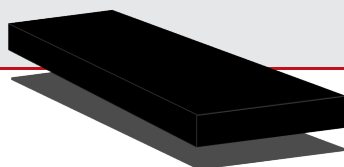

### germanShock® VS 60

#### Available dimensions:

Thickness:	30/40/50/60/75/80/100/125/150 mm
Width:	500/750 mm
Length:	1,000/1,500 mm



#### Specifications:

Colour:	black
Hardness:	60° [Shore A]
Surface:	plain
Mounting:	up to 80 mm thickness 5 mm steel plate above 80 mm thickness 10 mm steel plate

**Note:** Please order germanShock fasteners separately. Special materials on request.

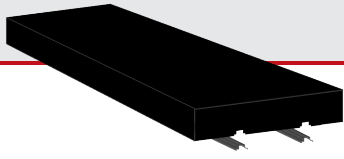

## germanShock® VC 60

### Available dimensions:

Thickness:	50/75/100/125/150 mm
Width:	500/750 mm
Length:	1,000/1,500 mm

### Specifications:

Colour:	black
Hardness:	60° [Shore A]
Surface:	plain
Mounting:	Two vulcanised aluminium fastening profiles

**Note:** Please order germanShock fasteners separately. Special materials on request.

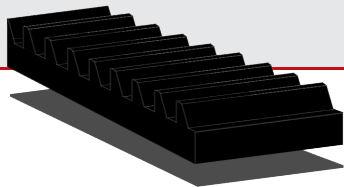

## germanShock® VSS 60

### Available dimensions:

Thickness:	55/80/100 mm
Width:	750 mm
Length:	1,500 mm

### Specifications:

Colour:	black
Hardness:	60° [Shore A]
Surface:	serrated
Mounting:	5 mm steel plate

**Note:** Please order germanShock fasteners separately. Special materials on request.

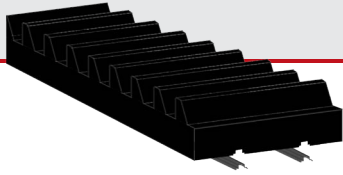

## germanShock® VCS 60

### Available dimensions:

Thickness:	55/80/100 mm
Width:	750 mm
Length:	1,500 mm

### Specifications:

Colour:	black
Hardness:	60° [Shore A]
Surface:	serrated
Mounting:	Two vulcanised aluminium fastening profiles

**Note:** Please order germanShock fasteners separately. Special materials on request.

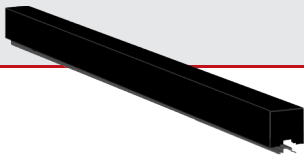

## germanShock® VB 60

### Available dimensions:

Height:	100/125/150 mm
Width:	100/125/150 mm
Length:	1,220/1,500 mm

### Specifications:

Colour:	black
Hardness:	60° [Shore A]
Surface:	plain
Mounting:	Vulcanised aluminium fastening profile

**Note:** Please order germanShock fasteners separately. Special materials on request.





## General view

Product	Height (mm)	Width (mm)	Length (mm)
germanShock® IP 60			
	50	100	1,220
		100	1,500
	75	100	1,220
		100	1,500
	100	100	1,220
		100	1,500
germanShock® IP 45			
	50	100	1,220
		100	1,500
	75	100	1,220
		100	1,500
	100	100	1,220
		100	1,500
germanShock® IP B	Type	Size	Length (mm)
	T35	M12	40
	T35	M16	60/90

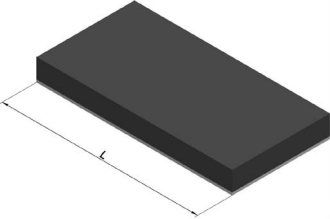
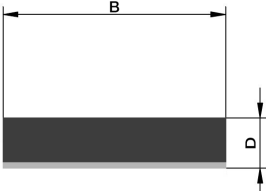
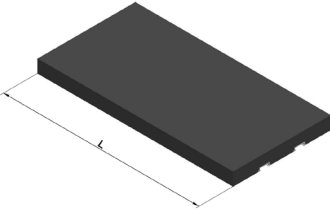
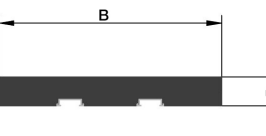
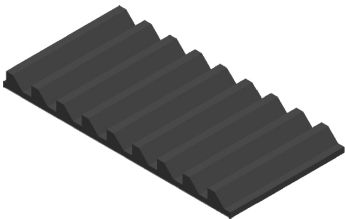
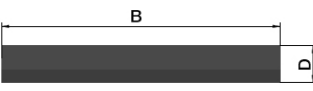
**Note:** germanShock IP elements come with 10 mm top cover of UHMWPE.  
Please order germanShock IP B fasteners separately. Special materials on request.

Product	Thickness (mm)	Width (mm)	Length (mm)
germanShock® VS 60			
  <b>Steel plate</b> D < 80 mm = 5 mm D > 80 mm = 10 mm	30	500/750	1,000/1,500
	40	500/750	1,000/1,500
	50	500/750	1,000/1,500
	60	500/750	1,000/1,500
	75	500/750	1,000/1,500
	80	500/750	1,000/1,500
	100	500/750	1,000/1,500
	125	500/750	1,000/1,500
	150	500/750	1,000/1,500
germanShock® VC 60			
  Two vulcanised aluminium fastening profiles	50	500/750	1,000/1,500
	75	500/750	1,000/1,500
	100	500/750	1,000/1,500
	125	500/750	1,000/1,500
	150	500/750	1,000/1,500
germanShock® VSS 60			
  <b>Serrated</b> 5 mm steel plate	55	750	1,500
	80	750	1,500
	100	750	1,500

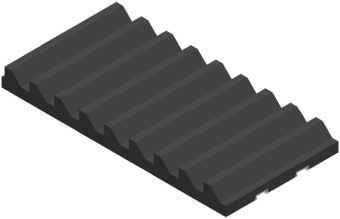
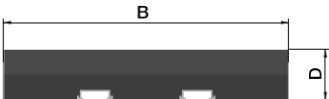
**Note:** Please order germanShock fasteners separately. Special materials on request.

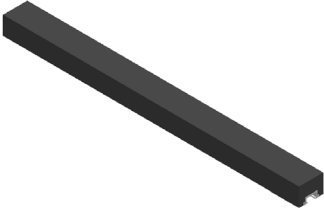
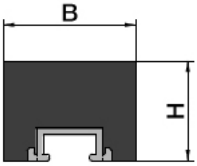
Product	Thickness (mm)	Width (mm)	Length (mm)
germanShock® VCS 60			
   <b>Serrated</b> Two vulcanised aluminium fastening profiles	55	750	1,500
	80	750	1,500
	100	750	1,500
germanShock® VB 60			
  <b>Wear protection bar</b> with vulcanised aluminium fastening profile	100	100/125/150	1,220
		100/125/150	1,500
	125	100/125/150	1,220
		100/125/150	1,500
	150	100/125/150	1,220
		100/125/150	1,500
germanShock® VS B	Type	Size	Length (mm)
	T35	M16	60/90
	T50	M20	50/80/110/140 150/200

**Note:** Please order germanShock fasteners separately. Special materials on request.

# germanBelt®

The content of this publication is non-binding and only serves informational purposes only. The information in this publication as well as the specified products and services may be changed or updated without notice at any time by the germanBelt GmbH. germanBelt®, germanShock® are registered trademarks. © 2011 germanBelt GmbH. All rights reserved.

**germanBelt GmbH**

Carl-Vollrath-Str. 8  
D-07422 Bad Blankenburg  
Germany

Tel.: +49 3573 36374-26

Fax: +49 36741 5680-79

E-Mail: [sales@germanBelt.com](mailto:sales@germanBelt.com)

Website: [www.germanBelt.com](http://www.germanBelt.com)

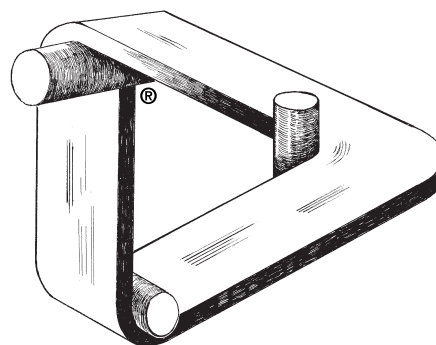

germanBelt ... beyond expectations